

Seifenspender  
Distributeurs de savon  
Distributori di sapone  
Distribuidores de jabón  
Soap dispenser

**KWC ONO**

**KWC EVE**

**KWC INOX**

**KWC ZOE**

**KWC AVA**

**KWC SIN**

**KWC PRIMO (2009)**

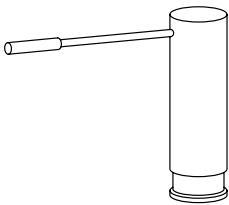

KWC ONO Z.536.060.000  
KWC ONO Z.536.060.700

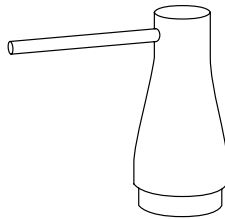

KWC EVE Z.536.063.000  
KWC EVE Z.536.063.700  
KWC EVE Z.536.063.150  
KWC EVE Z.536.063.151

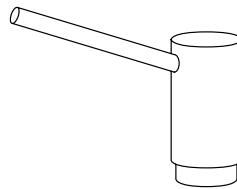

KWC INOX Z.536.062.700

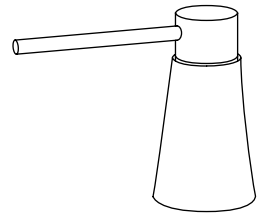

KWC ZOE Z.536.586.000  
KWC ZOE Z.536.586.106  
KWC ZOE Z.536.586.127  
KWC ZOE Z.536.586.150

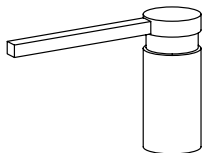

KWC AVA Z.536.159.000  
KWC AVA Z.536.159.127

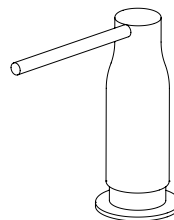

KWC SIN Z.536.332.000  
KWC SIN Z.536.332.127 (only for USA)

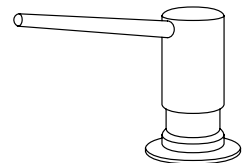

KWC PRIMO Z.536.109.000  
(Not for USA)

**KWC ONO**

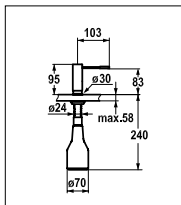

**KWC EVE**

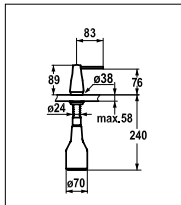

**KWC INOX**

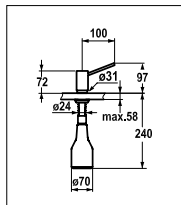

**KWC AVA**

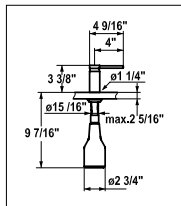
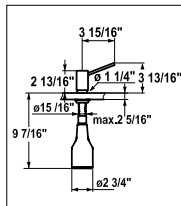
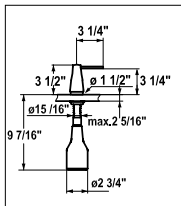
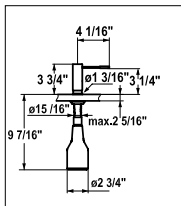
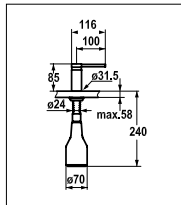

**KWC SIN**

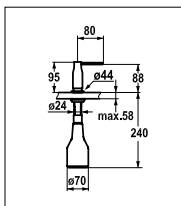

**KWC PRIMO**

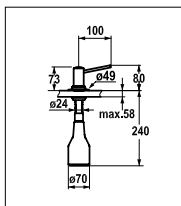

**KWC ZOE**

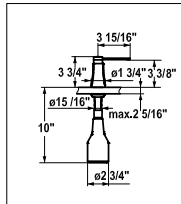
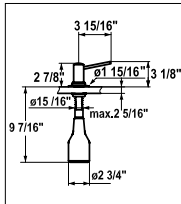
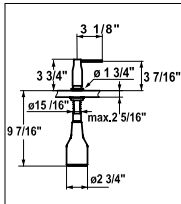
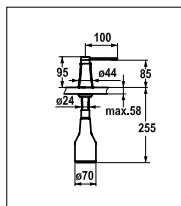

KWC VG  
KWC Deutschland GmbH  
Junghansring 70  
DE-72108 Rottenburg  
+49 (0) 7457 948 56 0  
+49 (0) 7457 948 56 30

Franke WS/KS  
Franke S.p.A.  
Via Pignolini 2  
IT - 37019 Peschiera del Garda  
+39 (045) 644 931 1

Franke WS/KS  
Franke Consumer Products  
Luxury Products Group  
800 Aviation Parkway  
 Smyrna, TN 37167 USA  
+1 800-626-5771

Franke WS  
Franke GmbH  
Oberer Achdamm 52  
AT-6971 Hard  
+43 (0) 557 467 350  
+43 (0) 557 462 411

Franke WS/KS  
Franke L.L.C.  
RAK Industrial Zone, P.O. Box 14511  
AE-Ras Al Khaimah, UAE  
+971 7 203 47 00  
+971 7 203 47 60

Franke WS  
Franke Washroom Systems  
Ring-Oost 10  
BE-9400 Ninove  
+32 (0) 54 31 01 30  
+32 (0) 54 31 01 35

Franke KS  
Franke NV  
Ring 10  
BE-9400 Ninove  
+32 (0) 54 31 01 11  
+32 (0) 54 32 36 88

Franke KS  
Franke GmbH  
Mumpferfahrstrasse 70  
DE-79713 Bad Säckingen  
+49 (0) 7761 52 0  
+49 (0) 7761 52 294

Franke KS  
Franke France S.A.S.  
Avenue Aristide Briand BP 13  
FR-60230 Chambly  
+331 30 28 94 00  
+331 30 28 94 30

Franke KS  
Franke UK Limited  
West Park, MIOC, Styal Road  
GB-Manchester M22 5WB  
+44 161 436 62 80  
+44 161 437 13 79

Franke KS  
Franke Nederland B.V.  
Lagedijk 13  
NL-5705 Bx Helmond  
+31 492 585 111  
+31 492 585 200

Montage  
 Montage  
 Montagio  
 Montajo  
 Installation

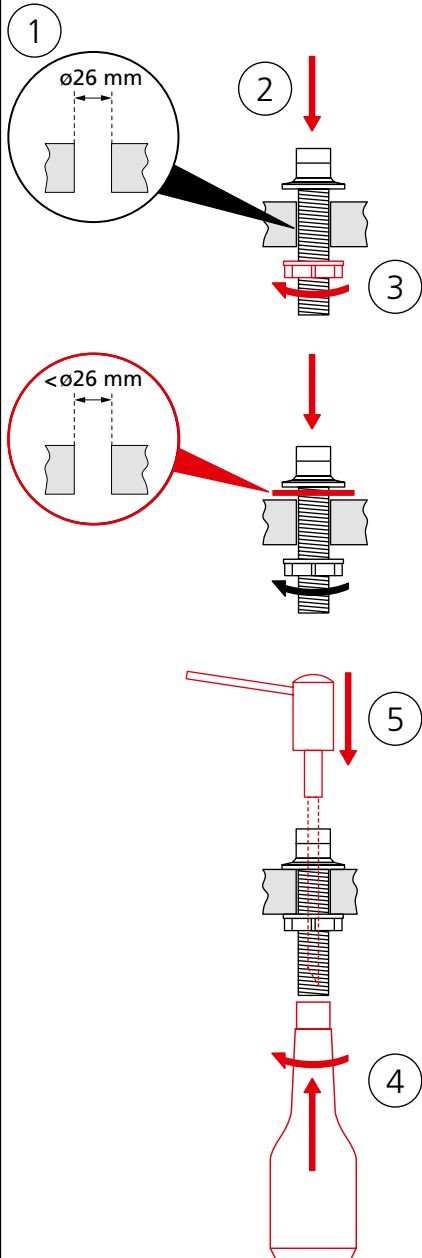

Inbetriebsetzung  
 Mise en service  
 Messa in funzione  
 Puesta en servicio  
 Initial operation

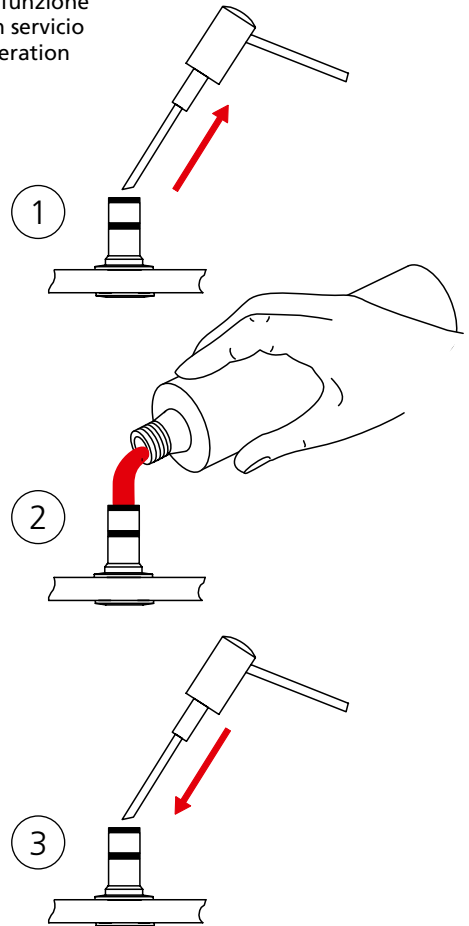

Ersatzteile  
 Pièces de rechange  
 Pezzi di ricambio  
 Repuestos  
 Spare parts

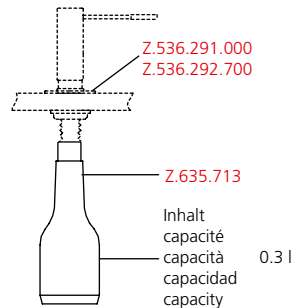

0.3 l

**Pflegeanleitung für Armaturen und Zubehör**  
**Instruction pour la maintenance des robinets et des accessoires**  
**Istruzioni per la manutenzione di rubinetti e accessori**  
**Instrucciones para el cuidado de griferías y accesorios**  
**Maintenance / Cleaning instructions for faucets and accessories**

**Grundsätzliche Reinigungshinweise:**

- Beim Reinigen muss die Oberfläche der Armatur kalt sein (Wärme beschleunigt die Zerstörung der Oberfläche)!
- Reinigungshinweise der Reinigungsmittelhersteller beachten!

**Die Pflege:**

- Armatur täglich mit weichem Lappen trocken reiben!
- Scheuernde Reinigungsmittel und Putzschwämme unbedingt vermeiden!

**Die Reinigung:**

- Schmutz- oder Kalkflecken auf der Armaturenoberfläche nur mit mildem Reinigungsmittel entfernen!
- Sofort nach dem Reinigen alle Reinigungsmittelrückstände mit kaltem Wasser wegspülen!
- Mit weichem Lappen trocken reiben.

**Instructions principales pour le nettoyage:**

- Durant le nettoyage, la surface du robinet doit être froide (la chaleur accélère l'usure de la surface)!
- Nous vous prions de faire attention aux indications mentionnées sur les nettoyages!
- Assurez vous que les produits ne contiennent pas d'acides ou des substances corrosives.

**L'entretien:**

- Le robinet doit être nettoyé chaque jour avec un chiffon mou.
- Evitez absolument l'usage des brillants pour métaux, éponges abrasives ou produits similaires!

**Le nettoyage:**

- Enlevez salissures et dépôts calcaires de la surface du robinet seulement avec des produits qui ne sont pas agressifs!
- Immédiatement après le nettoyage, rincer bien les résidus des détergents avec de l'eau froide!
- Sécher avec un chiffon mou.

**Principali istruzioni per la pulizia:**

- Durante la pulizia, la superficie del rubinetto deve essere fredda (il calore accelera il logorio della superficie)!
- Fare attenzione alle indicazioni riportate sui prodotti per la pulizia!
- Accertarsi che non contengano acidi o sostanze corrosive.

**La manutenzione:**

- Il rubinetto deve essere asciugato quotidianamente con un panno morbido.
- Evitare assolutamente paglietta, spugne abrasive o similari!

**La pulizia:**

- Togliere sporco e calcare dalla superficie del rubinetto solo con detersivi non aggressivi!
- Subito dopo la pulizia, sciacquare bene i residui di detersivo con acqua fredda!
- Asciugare con un panno morbido.

**Avisos básicos de limpieza:**

- Cuando se procede a limpiar la grifería, su superficie debe estar fría (el calor acelera la destrucción de la superficie)!
- Respetar los avisos de limpieza del fabricante del detergente!

**Cuidado:**

- Secar la grifería frotando diariamente con un paño blando!
- Evite, imprescindiblemente, detergentes y esponjas de limpieza raspantes!

**Limpeza:**

- Quitar las manchas de suciedad o cal en la superficie de la grifería sólo con un detergente poco agresivo!
- Inmediatamente después de la limpieza eliminar, enjuagando con agua fría, todos los residuos del detergente!
- Secar frotando con un paño blando.

**General Cleaning Instructions:**

- Faucet surface must be of room temperature before cleaning (elevated temperature increases damage of the surface).
- Cleaning instructions of the detergent manufacturer must be followed.

**Maintenance:**

- Rub the faucet daily dry with a soft cloth.
- Never use corrosive cleaners or cleaning pads.

**Cleaning:**

- Dirt or calcium deposits on the faucet surface must be removed with soft detergent or with soap water!
- Rinse well with water immediately after cleaning, until all detergent is removed from the surface.
- Dry with soft cloth.

**Skötsel och underhåll:**

- Blandaren skall vara rumstempererad innan rengöring (högre temperatur kan vara skadlig för ytbehandlingen).
- Instruktioner från rengöringsmedeltillverkaren skall följas.

**Underhåll:**

- Torka av blandaren dagligen med en mjuk trasa
- Använd aldrig kalklösande, sura- eller slipande skurmedel och svampar.

**Rengöring:**

- Smuts eller kalkavlagringar på blandarytan tas bort med mildt rengöringsmedel eller mild tvålösning.
- Eftersköljning med rent vatten tills allt rengöringsmedel är borta.
- Torka med mjuk trasa.

- D Schäden, die infolge unsachgemässer Behandlung, natürlicher Abnutzung oder zu grosser Inanspruchnahme entstanden sind, sind von unseren Garantieleistungen ausgeschlossen!
- F Ces dommages survenus en raison d'un traitement inadéquat, des signes d'usure traitement inadéquat, naturels ou du grand utilisation, sont exclus de notre garantie.
- I Danni ai rubinetti, conseguenti da un trattamento non appropriato, sono esclusi dalla nostra garanzia!
- Sp Daños, debidos a un tratamiento inadecuado, son excluidos de la nuestra garantía.
- E Damages on the faucet resulting from incorrect handling are excluded from the manufacturers warranty!
- S För att Garantin skall gälla skall blandaren vara monterad och använd på ett korrekt sätt.



Recyclingpapier auf 100% Altpapierbasis.  
 Papier de recyclage sur 100% bases de vieux papier.  
 Riciclaggio della carta sulla base della carta straccia di 100%.  
 Reciclaje del documento sobre base del papel usado del 100%.  
 Recycling paper on 100% waste paper basis.  
 Atervinning av papper 100%

Technische Änderungen vorbehalten

Salvo cambiamenti tecnici

Sous réserve de modifications techniques

Derechos reservados para efectuar modificaciones técnicas

Subject to technical alteration

Med förbehåll för tekniska ändringar